

EXPRESS



Lighting Control Console Quick Guide

Version 3.1

Copyright © Electronic Theatre Controls, Inc.
All Rights reserved.
Product information and specifications subject to change.
Part Number: **4110M1300-3.1** Rev A
Released: November 2002

ETC[®], Emphasis[™], Expression[®], Insight[™], Imagine[™], Focus[™], Express[™], Unison[®], Obsession[®] II, ETCNet2[™], EDMX[™], Sensor[®], and WYSILink[™] are either registered trademarks or trademarks of Electronic Theatre Controls, Inc. in the United States and other countries.

Table of Contents

Console Panels	1
Keypad Features	3
Introduction to Programming	6
Patching	7
Working with Channels.	8
Two-scene Operation.	9
Recording	12
Playback.	16
Disk Operations	17
Working with Moving Light (ML) Fixtures	18

Console Panels

Back panel

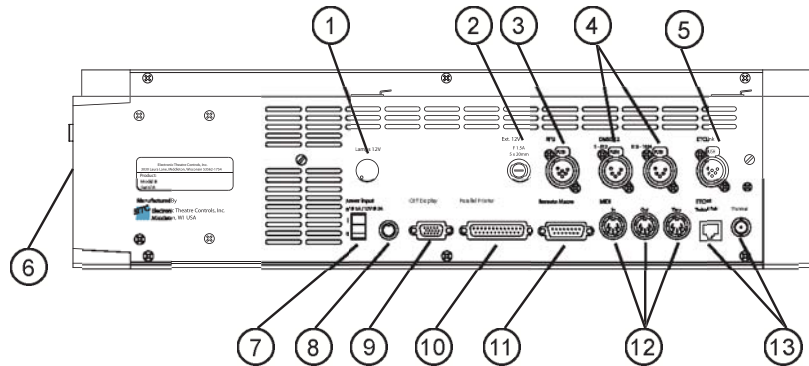

- | | |
|------------------------------------|---|
| 1. Desk Light Dimmer | 8. Power input connector |
| 2. RFU fuse (T2.5A) | 9. Command Display output |
| 3. RFU | 10. Parallel Printer |
| 4. DMX512 Out (2 universes) | 11. Remote Macros |
| 5. ETCLink | 12. MIDI In/Out/Thru |
| 6. Disk Drive (side) | 13. ETCNet (newer facepanels do not have Thin-net connector) |
| 7. Power switch | |

Face Panel (Express 125/250)

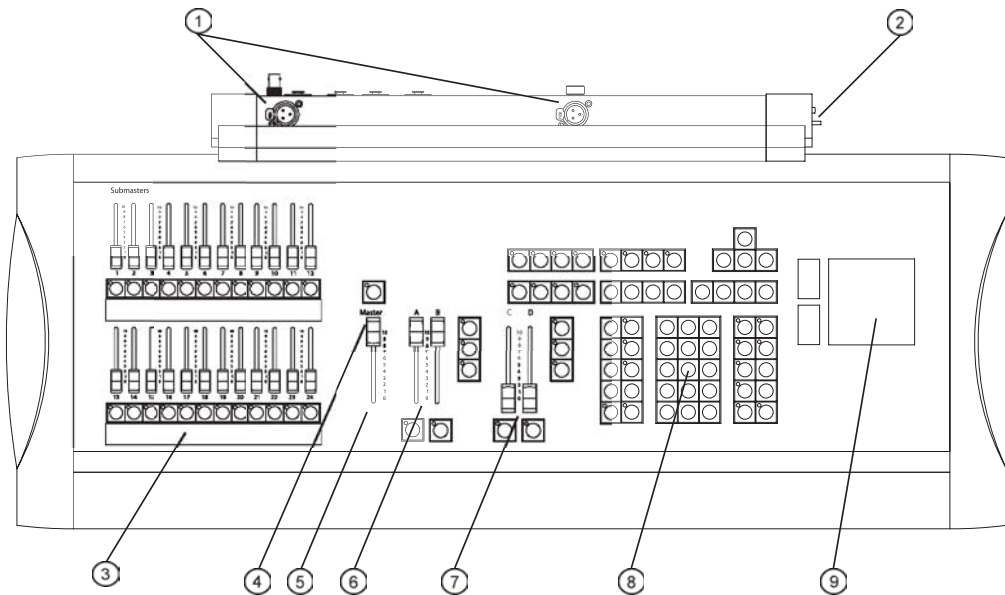

- | | |
|---------------------------------|-------------------------|
| 1. Desk Light connectors | 6. AB Fader pair |
| 2. Disk Drive (side) | 7. CD Fader pair |
| 3. Submaster faders | 8. Keypad |
| 4. Blackout key | 9. Trackpad |
| 5. Grandmaster | |

Face Panel (Express 24/48)

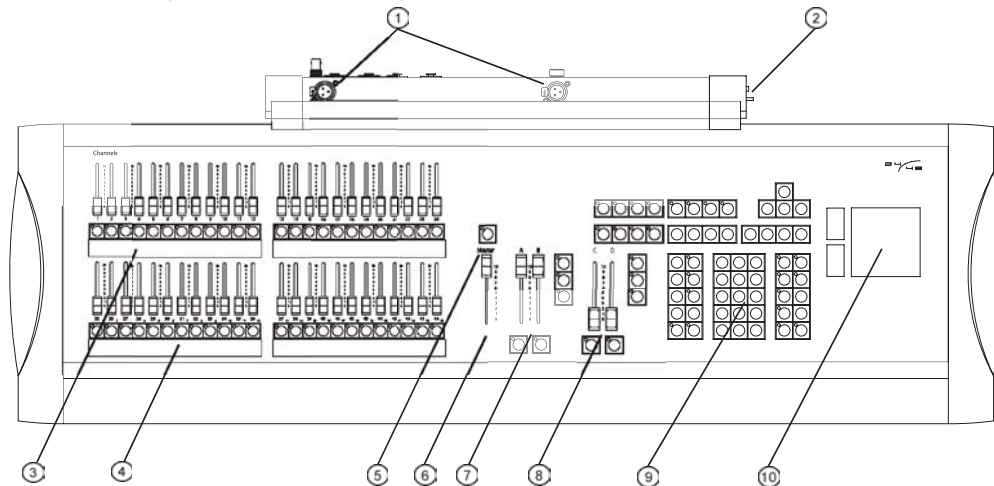

- | | |
|--|-------------------------|
| 1. Desk Light connectors | 6. Grandmaster |
| 2. Disk Drive (side) | 7. AB Fader pair |
| 3. Channel faders (Scene A) | 8. CD Fader pair |
| 4. Channel/Submaster faders (Scene B) | 9. Keypad |
| 5. Blackout key | 10. Trackpad |

Face Panel (Express 48/96, Express 72/144 is similar)

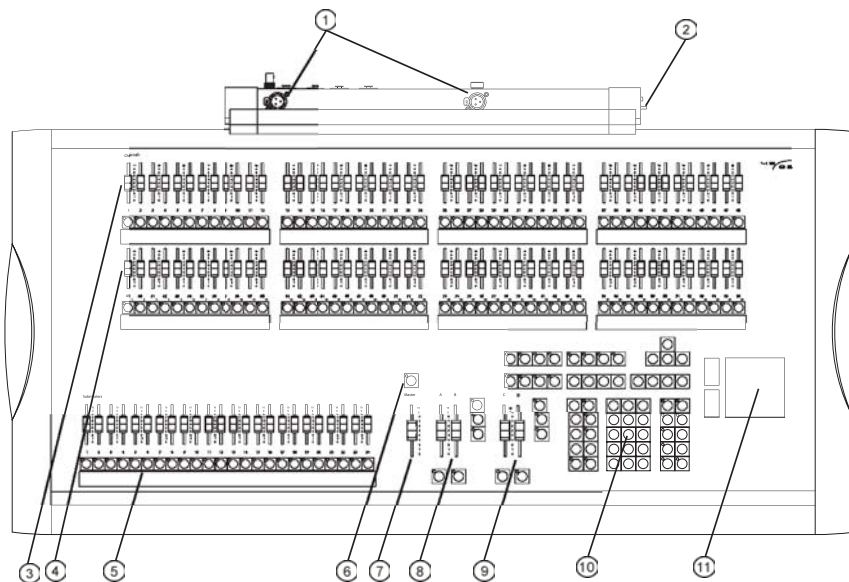

- | | |
|------------------------------------|-------------------------|
| 1. Desk Light connectors | 7. Grandmaster |
| 2. Disk Drive (side) | 8. AB Fader pair |
| 3. Channel faders (Scene A) | 9. CD Fader pair |
| 4. Channel faders (Scene B) | 10. Keypad |
| 5. Submaster faders | 11. Trackpad |
| 6. Blackout key | |

Keypad Features

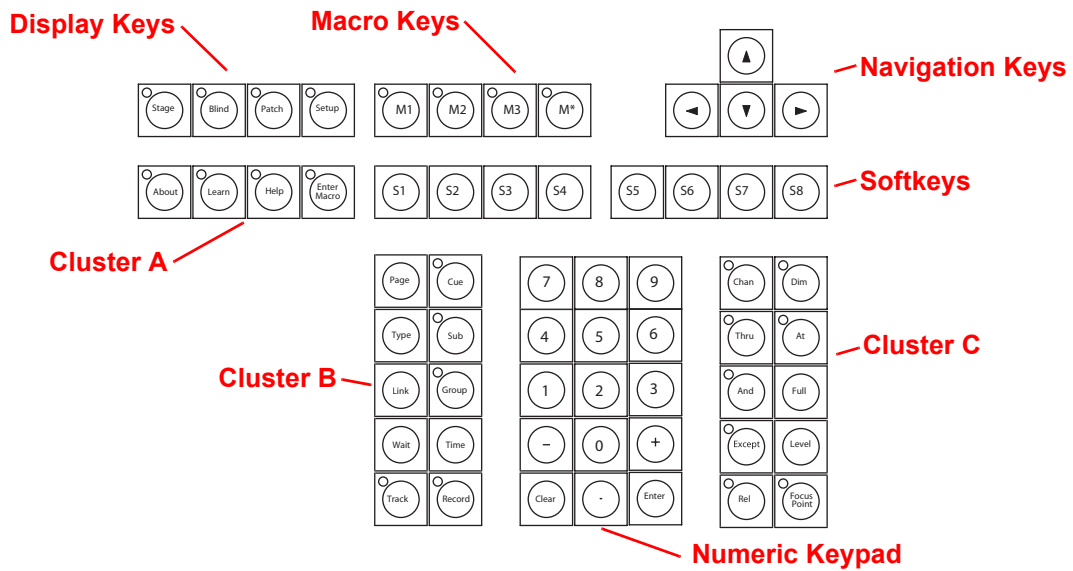

Display Keys

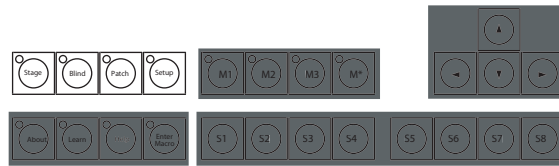

- The **[Stage]** display is where most editing of channel levels happens. In Stage, any changes you make are 'live' and will take immediate effect.
- The **[Blind]** display is used when you want to edit channel levels or cues but don't need or want a 'live' result. For example, if you are running a show and decide that you would like to add a channel at 50% to a cue, you can make the change in Blind and it won't affect the look currently on stage. The next time you play back your cue, the change takes effect.
- The **[Patch]** is used to assign dimmers to channels, and to modify dimmer attributes. View and edit your channel patch in this display.
- The **[Setup]** display is where you can edit the system settings for your console.

Macro Keys

Macro keys are used to program macro functions and start macros. Macro keys **[M1]–[M3]** access the first three macros directly; **[M*]** allows you to specify any one of the 2,000 macros available and must be followed by a number. **[Macro Enter]** is used when programming macros.

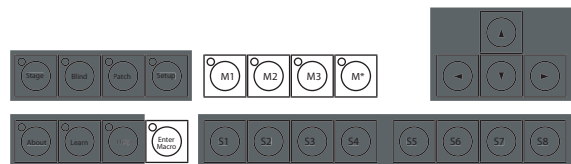

A macro is a recorded series of keystrokes to be replayed later. Macros can execute any console command (including softkeys and submaster bumps) and be linked to cues. For example, if you record **[Setup] [3] [Enter] [1] [Enter] [Enter] [Stage]** into a macro, with one keystroke you can save your show to disk and return to the Stage display. See your user manual for more information on recording macros.

Cluster A

- The **[About]** key opens a window containing information about a channel, dimmer, or the show according to which key you press after pressing **[About]**. For example, **[About] [Chan] [3] [Enter]** will display information about channel 3.
- The **[Learn]** key enables you to record keystrokes in real time into macros as an alternative to using editing screens.
- The **[Help]** key provides context-sensitive assistance online. Press **[Help]** followed by a second key (including softkeys) to open a window explaining the function of the second key.

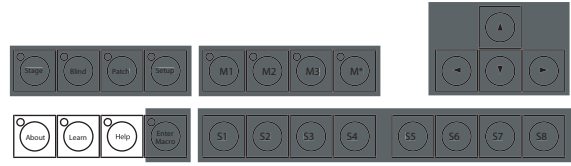

Navigation Keys

Use navigation keys to get around in displays, move through menus, move through fields in the Fixture Patch display, or move to different attributes or pages in the Fixture Box window.

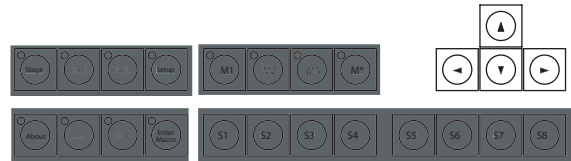

Softkeys

Softkeys are found in many console displays. They are identified for that display at the bottom of the screen. You activate a display's softkeys by pressing **[S1]–[S8]**. When softkey **[S7 - More Softkeys]** is available, there are more pages of softkeys for that display. Press **[S7 - More Softkeys]** to access those additional pages.

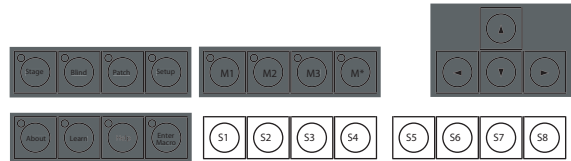

Cluster B

In general, the keys in this cluster pinpoint the elements that make up the structure of your show. You will use these keys when recording or editing groups, cues or submasters. Some allow you to change the properties of recorded elements, such as playback timing and relationships with other elements.

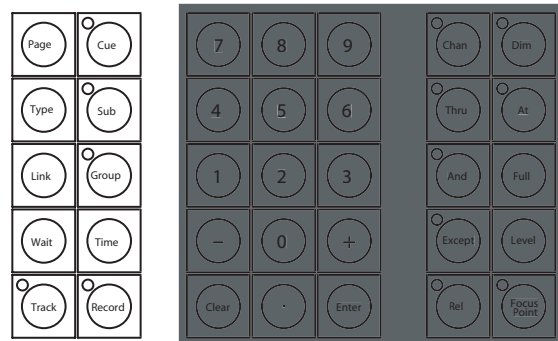

Numeric Keypad

The Numeric keypad is for numerical entry. This grouping also includes the **[Enter]** and **[Clear]** keys. Press **[Enter]** to complete operations. Press **[Clear]** to cancel operations.

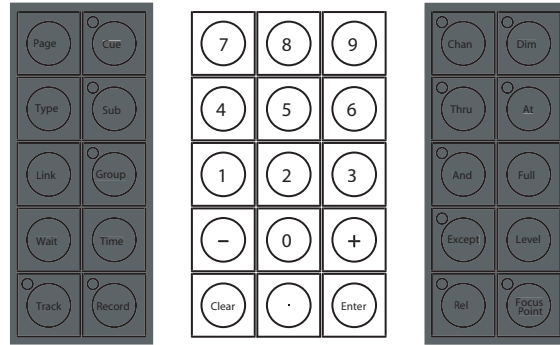

Cluster C

- Use these keys when editing channel levels and lists.
- Use the **[Thru]**, **[And]** and **[Except]** keys to work with multiple selections and ranges.
- Use **[At]** when making assignments, such as when setting channel levels.
- Use the **[Full]** and **[Level]** keys to assign pre-defined levels (there is no need to precede with **[At]** or follow with **[Enter]**).
- Use **[Rel]** to release selected, captured and independent channels. Selected channels may be edited in any display. Channels may be captured in the Stage or Fader displays and cannot be controlled by cues or submasters. Independent channels are unaffected by Grandmaster, Flash, Solo and Blackout controls. Press **[Rel]** 1–3 times to release channels in the following order: first selected channels, then captured channels, then independent channels.
- Use the **[Focus Point]** key to set levels by reference.

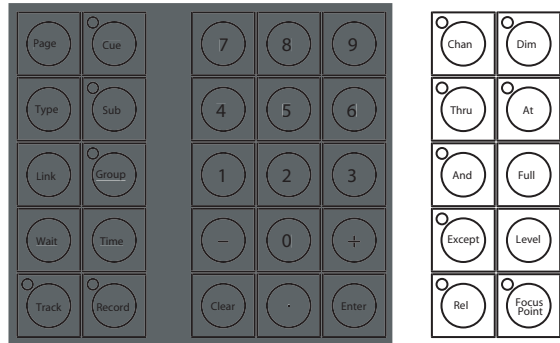

Introduction to Programming

The procedures explained in this introductory guide are grouped under the following categories:

- [Patching](#) ~ What it means and how to do it.
- [Working with Channels](#) ~ Select and set channel levels.
- [Two-scene Operation](#) ~ Using the manual playback features.
- [Recording](#) ~ Steps to follow to record cues, groups, submasters, focus points and effects (chases).
- [Playback](#) ~ See the results of your recordings.
- [Disk Operations](#) ~ Save and retrieve showfiles.
- [Working with Moving Light \(ML\) Fixtures](#) ~ Patch, select and set attribute levels.

Text Conventions

Many procedures are identified and explained by example on the following pages. To keep things simple and concise, we've adopted the following notations in this document.

- **[At], [Cue]** Keys (sometimes called buttons) found on the keyboard are shown with square brackets.
- **[S1 - Select Cue]** Softkeys in displays are shown with the softkey number and label bracketed in bold type. If a designated softkey is not visible in your display, you may need to press **[S7 - More Softkeys]** to scroll through the available pages.
- {Cue} Keys that are optional in a procedure are shown in curly brackets.
- **[#]** The numerical label of one or more elements, such as the number of a cue or the numbers of all channels in a selection list.
- **[x]** Values other than numerical labels, such as levels or times, are shown as an italicized "x" in square brackets. What "x" stands for will be defined in that step.
- [Channel Selection, page 8](#) References to instructions provided elsewhere in the Quick Guide are indicated in italics. When viewing this document electronically, click the reference to jump to that section.

Display Assistance

You will find context-sensitive assistance in two places on Command monitor screens. In the upper right corner the console tells you what entry is expected next. In red text just above the softkeys, the console gives you instructions and identifies your options.

Setup Display

Your console comes with default settings that can be changed in the Setup display. These settings have an overall affect on your shows and on the programming environment. Enter the Setup display by pressing **[Setup]** on the console keypad. Navigate to a Setup menu, and through subsequent menus, by pressing the menu's number followed by **[Enter]**.

Patching

Conventional lights are powered by *dimmers*, which in turn are controlled by console control *channels*. You associate certain dimmers with certain channels by performing a *patch* in the Patch display, and then record the channels into show elements such as *cues*, *groups* or *submasters*. You may patch more than one dimmer to a channel, but dimmers may only be assigned to one channel at a time. Your console is shipped with a default patch that associates each dimmer with control channels on a 1:1 basis.

When there are moving lights in your show, you need to use the Setup menu Moving Light Functions menu to patch the multiple attributes of those fixtures (see [Working with Moving Light \(ML\) Fixtures, page 18](#)).

Patch dimmers to channels:

Step 1: Press **[Patch]** to go to the channel patch display.

Step 2: Press {Dim} **[#]** **[Enter]** {Channel} **[#]** **[Enter]**. Repeat for all the dimmers you want to patch.



Note: If the LED on the **[Channel]** key is lit before you start, you must press **[Dim]** before entering the first number. To unpatch, use the same procedure but press "0" for the channel number, or press **[Dim] [#] [S6 - Unpatch]**.



Working with Channels

Channel Selection

To set a level for a channel, you must select it. Selecting a channel is as easy as pressing its number on the keypad. You may also use the **[And]**, **[Thru]** and **[Except]** keys to select ranges of channels. The Stage display will default to channel selection. The Blind display defaults to cue selection, so you will need to press the **[Channel]** key prior to entering channel numbers.

Select channels:

- Press **[Channel] [#]**.
- To select a range of channels press **[Channel] [#] [Thru] [#] [And] [#]**.



Note: *In the Stage display, the **[Channel]** key is optional when the channel LED is lit.*

*To remove channels from a range, use the **[Except]** key. **[Channel] [1] [Thru] [10] [Except] [5] [And] [Except] [7]** selects channels 1-4, 6, and 8-10.*

Set Channel Levels

After making a channel selection, set channel levels using any of the procedures below. You may also set channel levels by referencing focus points, but that procedure usually is employed for setting attribute levels for moving light fixtures. Information about focus points is given in [Focus Points, page 21](#).

Using the trackpad:

- Slide your finger vertically on the trackpad. Press the coarse and fine “buttons” to the left of the trackpad to adjust the sensitivity of the trackpad.



Using the numeric keypad:

- Press **[At] [x] {Enter}**. **[x]** can be a single- or double-digit entry. For 50%, you can type **[At] [5][0]**, or you can type **[At] [5] Enter**. For a level of 5%, you must enter **[At] [0][5]**.

Using pre-defined levels:

- Press **[Full]** or **[Level]**. You can change the value of the **[Level]** key in the Systems Settings menu.
- Press **[At] [Clear]** to quickly set channels to 0%.

Using the [+] and [-] keys:

- Press **[At]** followed by pressing the **[+]** or **[-]** keys as often as you wish to increment or decrement the level by one percent.

Two-scene Operation

Overview

You can use the Express 24/48, 48/96 and 72/144 consoles in “single-scene” or “two-scene” mode. In single-scene operation, the channel faders access the first 48, 96 or 144 channels, based on the console type.

In two-scene operation, the top and bottom rows of channel faders access the first 24, 48 or 72 channels. For example, on an Express 24/28, fader 1 and 25 will both access channel 1, faders 2 and 26 access channel 2, and so on. Two-scene mode allows you to setup lighting looks manually on the channel faders and crossfade between them. In all cases, two-scene mode uses the top row of channel faders as “Scene A” and the bottom row of channel faders as “Scene B”. When you are running in two-scene mode, the AB Fader pair is used to crossfade from Scene A to Scene B. You can crossfade manually or with timing applied. You can use the CD Fader Pair to playback recorded cues (see [Cues, page 12](#), for more information).



Note: *The Express 24/48 also has the ability to run in single-scene mode with channel and submaster faders available. In that case, the top row of channel faders correspond to channels 1-24, and the bottom row becomes submasters 1-24.*

Setup Two-scene Operation

To change the operation mode of your Express 24/48, 48/96 or 72/144, you will need to use the Setup display. Once you have enabled two-scene operation, the AB Fader Pair can only be used for crossfading between Scene A and Scene B. If you want to playback recorded cues on the AB Fader Pair, you will need to return to single-scene operation.

Setup two-scene operation:

- Step 1: Press **[Setup] [1] [Enter]** to open the System Settings menu.
- Step 2: Press **[1][5] [Enter]** to select the Scene Mode settings.
- Step 3: Press **[1] [Enter]** to set the console to two-scene operation.
- Step 4: Press **[Stage]** to return to the Stage display.

Setup single-scene operation:

- Step 1: Press **[Setup] [1] [Enter]** to open the System Settings menu.
- Step 2: Press **[1][5] [Enter]** to select the Scene Mode settings.
- Step 3: On Express 48/96 and 72/144 consoles, press **[0] [Enter]** to return to single-scene operation. On Express 24/48 consoles, you have two single-scene choices: press **[2] [Enter]** for single-scene operation *without* submasters, or press **[3] [Enter]** for single-scene operation *with* submasters.
- Step 4: Press **[Stage]** to return to the Stage display.

Playback Looks Manually using the AB Fader Pair

Channel faders are “mastered” by the AB Fader Pair when two-scene operation is enabled. This means that the top row of channel faders, Scene A, will be active when the A Fader in the AB Fader Pair is at the top of its travel (farthest away from you). Channel faders in the bottom row, Scene B, are active when the B Fader in the AB Fader Pair is at the bottom of its travel (closest to you).



Note: If you place the A Fader and B Fader off their respective zero position (for example, both at full), both Scene A and Scene B become active. In that case, the channel fader at the highest level will control the output for that channel.

Playback lighting looks manually:

- Step 1: Slide the AB Fader Pair to the top of their travel (away from you).
- Step 2: Move the channel faders on Scene A to the levels you want in your first look (Cue 1). Lighting levels will change on stage.
- Step 3: Move the channel faders on Scene B to the levels needed in the *next* look (Cue 2). This will not affect the stage output.
- Step 4: Slide the AB Fader Pair toward you to crossfade from Scene A (Cue 1) to Scene B (Cue 2). The speed at which you move the AB Faders determines the rate of change on stage.
- Step 5: Move the channel faders on Scene A to the levels needed in the *next* look (Cue 3). This will not affect the stage output.
- Step 6: Slide the AB Fader Pair away from you to crossfade from Scene B (Cue 2) back into Scene A. Since you have changed the channel levels on Scene A, you have crossfaded into “Cue 3”.
- Step 7: Continue this process to fade from cue to cue manually.

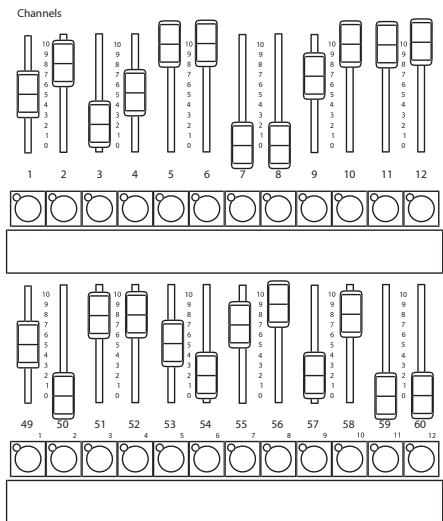

Note: You can flash scenes to full output using the **[AB-Clear]** and **[AB-Back]** keys. Use the **[AB-Clear]** key to flash Scene A, and the **[AB-Back]** key to flash Scene B.

Playback Looks with Timing

For long crossfades, you may not want to crossfade manually between scenes. You can set timing values for the upfade and downfade movement on the AB Fader Pair. The crossfade is started by moving the AB Faders fully away from you or fully toward you. The scene that is fading in will follow the upfade time, and the scene that is fading out will follow the downfade time.

Crossfade scenes using timing:

- Step 1: Slide the AB Fader Pair to the top of their travel (away from you).
- Step 2: Move the channel faders on Scene A to the levels you want in your first look (Cue 1). Lighting levels will change on stage.

- Step 3: Move the channel faders on Scene B to the levels needed in the *next* look (Cue 2). This will not affect the stage output.
- Step 4: Press **[AB-Rate] [x] [Enter]**, where [x] is the upfade time.
- Step 5: Press **[x] [Enter]**, where [x] is the downfade time. If the downfade time is the same as the upfade time, just press **[Enter]**. The Rate key will blink to indicate that it is active.
- Step 6: Move the AB Faders toward you. When they reach the end of travel, the timed fade will begin. Timing will remain active on the AB Fader Pair until you press **[AB-Rate]** again.

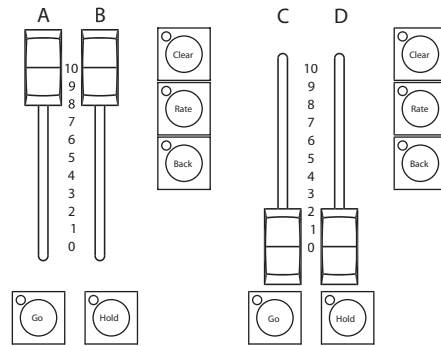

Note: You can pause a timed crossfade using the **[AB-Hold]** key. To resume the fade, press **[AB-Go]**.

Recording

You can record channel levels into submasters, groups and cues in both the Stage and Blind displays. Remember that working in Stage affects the output of the console. Changes made in Blind affect only the stored data. If you modify a cue in Blind, you must play it back in Stage to see the changes in real life.

Cues

A lighting cue is typically a “look” on stage that can be played by pressing a fader Go key. You create a cue by selecting patched channels, setting their levels and recording all this information to a cue number. After that, adjust playback timing if you wish.

Record a cue in Stage:

- Step 1: Press **[Stage]** to enter the Stage display.
- Step 2: Select channels using the procedure [Select channels](#), page 8.
- Step 3: Set levels for those channels using the procedure [Set Channel Levels](#), page 8.
- Step 4: Press **[Record] [Cue] [#] [Enter]**.



Note: For information on Effect cues, see [Effects \(Chases\)](#), page 14.

Cue Fade and Wait Times

Recorded cues will default to the upfade and downfade times set in the System Settings menu (the console defaults to five second up- and downfades). Cue fades start as soon as you press [Go], but you can delay fades by setting upfade and downfade *wait* times.

Set a new default fade time:

- Step 1: Press **[Setup] [1] [Enter]** to view the System Settings menu.
- Step 2: Press **[3] [Enter] [x] [Enter] {x} [Enter]**, where **[x]** is the new default upfade time, and **{x}** is the new downfade time if it is different from the upfade time.

Edit cue fade times:

- Step 1: Select the **[Stage]** or **[Blind]** display.
- Step 2: Press **[Cue] [#] [Time] [x] [Enter] {x} [Enter]**, where **[x]** is the new cue upfade time, and **{x}** is the new downfade time if it is different from the upfade time. If you want to change only the downfade time, press **[Time]** twice before entering a value.

Edit cue fade wait times:

- Step 1: Select the **[Stage]** or **[Blind]** display.
- Step 2: Press **[Cue] [#] [Wait] [x] [Enter] {x} [Enter]**, where **[x]** is the new cue upfade wait time, and **{x}** is the new downfade wait time if it is different from the upfade time. If you want to change only the downfade wait time, press **[Wait]** twice before entering a value.

Groups

A *group* is a recorded set of channels at specific levels. Groups can be used to select channels and set levels that you use repeatedly through a programming session. Groups are not played back like cues, so they do not have timing associated with them.

Record a group:

- Step 1: Press **[Stage]** to enter the Stage display.
- Step 2: Select channels using the procedure [Select channels](#), page 8.
- Step 3: Set levels for those channels using the procedure [Set Channel Levels](#), page 8.
- Step 4: Press **[Record] [Group] [#] [Enter]**.



Note: When creating a group in *Blind*, you should press **[Group] [#] [Enter]** first to select the group you are creating. This will ensure that you start with an empty group.

Submasters

You can record a lighting look or an effect to a submaster and then play back the recording proportionally with the submaster's fader, or force it to full output using the submaster *bump button*. You can also apply timing to a submaster and play it back using the submaster's bump button. When played back, the submaster will typically pile-on recorded channels to the stage look.

Submasters

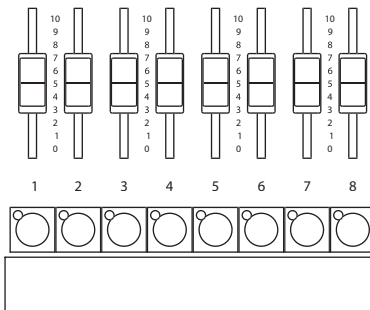

Record a submaster:

- Step 1: Press **[Stage]** to enter the Stage display.
- Step 2: Select channels using the procedure [Select channels](#), page 8.
- Step 3: Set levels for those channels using the procedure [Set Channel Levels](#), page 8.
- Step 4: Press **[Record] [Sub] [#] [Enter]**. You can also press **[Record]** and then press the target submaster's bump button.

Effects (Chases)

An *effect* is a special cue or submaster that can run repetitively in a variety of patterns. Effects are also called *chases*. Effects consist of a series of steps that contain channels set at levels. You can assign timing conditions to each step and separately to the overall effect. You can record an effect in the Stage or Blind display, but you can only edit effects in Blind.



Record an effect in Blind (example):

- Step 1: Press **[Blind]** to enter the Blind display.
- Step 2: Press {Cue} **[#]** **[Type]** **[3]** **[Enter]** to specify the cue number and set it to the effect type. This also selects Step 1 for editing.
- Step 3: Press **[Channel]** **[1]** **[Thru]** **[5]** **[S8 - Add Channels]** **[At]** **[5]****[0]** to set channels 1-5 to a maximum level of 50%. You can also select channels individually to set levels after you add them.
- Step 4: Press **[S1 - Step]** **[2]** to create the next step and select it for editing.
- Step 5: Press **[Channel]** **[6]** **[Thru]** **[1]****[0]** **[S8 - Add Channels]** **[At]** **[7]****[5]** to add channels 6-10 to step 2 and set them to a maximum level of 75%.
- Step 6: Press **[Record]** **[Enter]** to record the effect cue.

Effect Fade Times

When an effect is created, it defaults to zero timing for overall fade and step fades. Each step defaults to a .2 second step time, which means that step 2 plays .2 seconds after step 1, and so on. You can change the timing on the overall effect, which will determine how long it takes for the whole effect to fade to maximum levels, stay active and fade out again. You may also add in, dwell and out times to each step to change from a chase that snaps between the minimum and maximum levels to one that fades. If the In/Dwell/Out time combined is greater than the step time, your steps will crossfade from one to the next.

Change an effect cue's overall timing:

- Step 1: Press **[Blind]** to enter the Blind display.
- Step 2: Press {Cue} **[#]** **[Time]** **[x]** **[Time]** **[x]** **[Time]** **[x]** **[Enter]**, where the first time number entered is for the upfade time, the second is for the dwell time and the third is for the downfade time. Any of the three can be skipped by pressing **[Time]** without following it with a number. The dwell time is the amount of time the effect

stays active before fading itself down. A dwell time of "Hold" will keep the effect running until the next cue is played.

Step 3: Press **[Record] [Enter]** to save your changes.

Change an effect step's timing:

Step 1: Press **[Blind]** to enter the Blind display.

Step 2: Press {Cue} **[#] [Enter]** to select the effect cue you want to edit.

Step 3: Press **[S1 - Step] [#] [Enter] [S7 - More Softkeys] [S3 - In/Dwell/Out][x] [Enter] [x] [Enter] [x] [Enter]**, where the first time number entered is for the in time, the second is for the dwell time and the third is for the out time. Any of the three can be skipped by pressing **[S3 - In/Dwell/Out]** without following it with a number. The dwell time is the amount of time the step stays active before fading itself down.

Step 4: Press **[Record] [Enter]** to save your changes.

Effect Attributes

You can change the way an effect plays by changing its attributes. Effects are either Positive or Negative but can have other attributes as well (for example, Reverse, Bounce and Random).

Change an effect cue's attributes:

- Press **[Blind] {Cue} [#] [S7 - More Softkeys] [S8 - Attribute]**, and select from the softkeys. To remove an attribute, press the corresponding softkey again.

Playback

Cue playback takes place in the AB and CD Fader pairs in single-scene mode, or just the CD Fader pair in two-scene operation. Playback is controlled by the **[Go]**, **[Clear]**, **[Hold]**, **[Back]** and **[Rate]** keys.

- **Play a cue** Press {Stage} **[Cue] [#] [Go]**, using the **[Go]** key of the AB or CD faders. To playback the cue using the recorded timing, move both fader sliders to level 10 before you press **[Go]**. If playing back in manual timing, move both fader sliders to level 0 before you press **[Go]**, then move the sliders in your own timing. pressing **[Go]** again plays the next cue in the cue list.
- **Clear a cue** Press a fader's **[Clear]** key to remove the current cue from that fader. You may need to press **[Clear]** twice to remove an effect cue from the fader.
- **Hold a cue** Press a fader's **[Hold]** key to pause the playback of a cue. Press **[Go]** to resume the fade.
- **Move back** Press a fader's **[Back]** key to replay the cue that played just previously in that fader. Press **[Back]** again to move backward in order in that fader. Press **[Go]** to move forward in order in that fader.
- **Rate control** Press a fader pair's **[Rate]** key to take manual control of the cue's fade rate with the trackpad. This command is especially useful for effect cues.

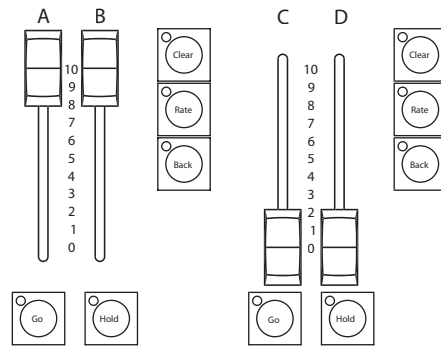

Disk Operations

When you write to a diskette, both the show programming and the console's configuration are stored to the diskette. However, you may read show and configuration information separately from a showfile stored on diskette. Reading these two components separately allows you to conveniently keep system configuration preferences the same, such as default settings and hardware setup, even when you run different shows.

Insert a 1.44 MB high density diskette into the console's disk drive, then proceed as follows to write to or read from the diskette.

Write to diskette:

Step 1: Press **[Setup] [3] [Enter]** to view the Disk Functions menu.

Step 2: Press, **[1] [Enter] [Enter]** to write the show to diskette.

Read only the show information:

Step 1: Press **[Setup] [3] [Enter]** to view the Disk Functions menu.

Step 2: Press **[2] [Enter] [Enter]** to read show data from the diskette.

Read only the configuration information:

Step 1: Press **[Setup] [3] [Enter]** to view the Disk Functions menu.

Step 2: Press **[3] [Enter] [Enter]** to read system configuration from the diskette.

To format the diskette:

Step 1: Press **[Setup] [3] [Enter]** to view the Disk Functions menu.

Step 2: Press **[4] [Enter] [Enter]** to format the diskette.

Read all data from diskette:

Step 1: Press **[Setup] [3] [Enter]** to view the Disk Functions menu.

Step 1: Press **[5] [Enter] [Enter]** to read all data from the diskette.

Working with Moving Light (ML) Fixtures

Patching ML Fixtures

Use the Fixture Patch display to patch one or more ML fixtures at a time. When you patch multiple fixtures at once, Start Channels and DMX512 Start addresses will auto-increment to the next available address. Note that resulting Intensity Channels are identified in the table. Moving lights are selected by *fixture number* for control.

The screenshot shows the 'Fixture Patch' screen with a table of fixture data. The table has columns for Fixture Number, Label, Personality, Start Chan, DMX512 Start, Remote Dimmer, Swap Focus, Flip, and Intensity Chan. The data is as follows:

Fixture Number	Label	Personality	Start Chan	DMX512 Start	Remote Dimmer	Swap Focus	Flip	Intensity Chan
1		1 Cyberlight	1	1/1	n			18
2		1 Cyberlight	21	1/21	n			38
3		1 Cyberlight	41	1/41	n			58
4		1 Cyberlight	61	1/61	n			78

Below the table, there is a red prompt: 'Select fixture number(s)'. At the bottom, there is a menu with 8 options: 1 Select Fixture, 2, 3 Personality, 4 Previous Page, 5 Next Page, 6 Delete Fixture, 7 More Softkeys, 8 Return.

Patch moving light fixtures:

- Step 1: Press **[Setup] [1][5] [Enter]** to view the Moving Light Functions menu.
- Step 2: Press **[2] [Enter]** to view the moving light Fixture Patch display.



Note: You can also access the Fixture Patch from the Patch display. Press **[S8 - Fixture Patch]** in the Patch display to switch over to the Fixture Patch.

- Step 3: Press **[S1 - Select Fixture] [#] [Enter]** to select the fixture number you want to patch. You can patch multiple fixtures at one time by pressing **[S1 - Select Fixture] [#] [Thru] [#] [Enter]**.
- Step 4: Press **[#] [Enter]** to set the personality number. If you do not know the personality number, press **[S8 - Return] [1] [Enter]** to view the Personality Setup display. Press **[S8 - Return] [2] [Enter]** to return to the Fixture Patch display.



Note: If your fixture is not listed, there may be a personality already built and available for download at http://www.etconnect.com/service/service_xprn_pers.asp. You can build a profile using the Expression Personality Editor that came with your console. If you do not have the Expression Personality Editor, you can download it at http://www.etconnect.com/service/service_offline_software.asp?10

- Step 5: Press **[#] [Enter]** to set the start channel of the first (or only) selected fixture. This value cannot be patched to another fixture.

- Step 6: Specify the DMX512 Start address by pressing **[#] [Enter] [#] [Enter]**, where the first number entered is 1, 2 or 3 to set the output port, and the second number is 1-512 for the DMX512 Start address for the first (or only) selected fixture.
- Step 7: If the fixture requires a remote dimmer, press **[#] [Enter]**, where the number is the DMX512 address for that dimmer. If there is no remote dimmer, press **[Enter]** to skip over this column.
- Step 8: Press **[1] [Enter]** to swap the pan and tilt attributes on a fixture. This is useful when the hanging position of a fixture makes the pan movement look more like tilt, and vice versa. If you do not want to swap the pan and tilt attributes, press **[Enter]** to skip this setting.
- Step 9: The Flip setting inverts the movement of pan and/or tilt movement for a fixture. Press **[Enter]** to skip, or **[1] [Enter]** to flip the pan movement. Press **[Enter]** to skip, or **[1] [Enter]** to flip the tilt movement. Flip is useful when the hanging position of a fixture causes the pan or tilt of a fixture to move opposite other fixtures, such as when moving-mirror fixtures are hung head-to-head.

Fixture Box

When a fixture is selected, a special window called the Fixture Box appears at the bottom of the Command display. All channels belonging to a particular fixture and assigned to encoder control are displayed in five encoder pages.

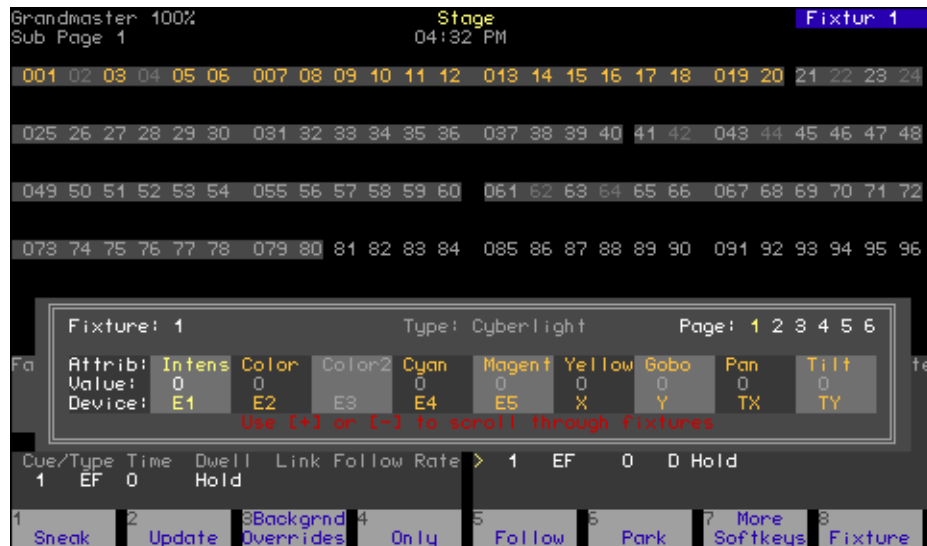

Operating in the Fixture Box:

- Scroll through fixtures Press **[+]** or **[-]**
- Scroll through attributes Press **[←]** or **[→]**
- Scroll through attribute pages Press **[↑]** or **[↓]**

Select ML Fixtures

To control a moving light, you must select it. Selecting a moving light is done by the fixture number you set in the patch. You may also use the **[And]**, **[Thru]** and **[Except]** keys to select ranges of fixtures.

Select fixtures:

- Press **[S8 - Fixture] [#]**.
- To select a range of fixtures press **[S8 - Fixture] [#] [Thru] [#] [And] [#]**. When a range of fixtures is selected, only the last fixture in the range is displayed in the Fixture Box.

Select a Fixture Attribute

Your console supports up to 64 fixture attributes. These attributes are numbered 1-64. Though you can directly change attribute levels directly using the encoders, you may select a particular attribute by selecting its number.

When selecting an attribute by its number, the attribute is highlighted in the Fixture Box. The steps to follow to select a fixture attribute are illustrated below.

View the attribute numbers:

- Step 1: Press **[Setup] [1][5] [Enter]** to view the Moving Light Functions menu.
- Step 2: Press **[3] [Enter]** to view the Attribute Setup display. All attributes have a number associated with them.

Select a fixture attribute:

- Step 1: Press **[S8 - Fixture] [#] [Only] [S6 - Attribute] [x]**, where [x] is the attribute number you want to select.
- Step 2: Use the associated encoder to set a level, or press **[At] [x]**, where [x] is the level you want to set for that attribute.

Select Attributes by Category

Each attribute is assigned by default to one of five categories: Position, Beam, Image, Color or None. Often, you may want to adjust or record all the attributes in a category.

Select all the attributes in an attribute category:

- Step 1: Press **[S8 - Fixture] [#] [Only] [S1 - Position]** to select the position attributes. You can substitute **[S2 - Image]**, **[S3 - Color]**, **[S4 - Beam]** or **[S5 - None]** for **[S1 - Position]** to select other attribute categories.
- Step 2: Use the associated encoder to set a level, or press **[At] [x]**, where [x] is the level you want to set for that attribute.

Set Attribute Levels

After making ML fixture and attribute selections, set attribute levels using any of the procedures below. Since attributes are associated with channels in Fixture Patch, you can set attributes levels using the procedures given under [Set Channel Levels, page 8](#). But easier ways are available for ML fixtures that employ the Fixture Box and reference groups called Focus Points.

Find out which device controls which attribute by selecting a fixture, then looking in the Fixture Box. The attributes of the fixture and their associated level-setting devices are highlighted. The devices are shown in the third row of the table, where E1–E5 are encoders, X and Y are the two wheels, and TX and TY are the two axes of the pointing device. These

encoder assignments refer to the Expression 3 and Insight 3 hardware. On an Express console, use the navigation keys to move among attributes and pages. When pan or tilt is selected, the trackpad can be used to control movement.

Setting the intensity directly:

- Step 1: Select fixtures using the procedure described in [Select ML Fixtures, page 20](#).
- Step 2: Press **[At] [x]**, where [x] is the intensity level. You can also use the **[Full]** and **[Level]** keys.

Using Focus Points (see below):

- Step 1: Select fixtures using the procedure described in [Select ML Fixtures, page 20](#).
- Step 2: Select an attribute or attribute category using the procedures [Select a Fixture Attribute, page 20](#) or [Select Attributes by Category, page 20](#).
- Step 3: Press **[At] [Focus Point] [#] [Enter]**.

Using encoder settings:

- Step 1: Select fixtures using the procedure described in [Select ML Fixtures, page 20](#).
- Step 1: Select an attribute or attribute category using the procedures [Select a Fixture Attribute, page 20](#) or [Select Attributes by Category, page 20](#).
- Step 2: Use the arrow keys and trackpad to set attribute levels.

Focus Points

Focus points are special groups that are used by reference. They are most often used to set the levels of ML fixtures. Levels that reference a focus point automatically update if the corresponding levels in the focus point change.

Record a Focus Point:

- Step 1: Press **[Stage]** to enter the Stage display.
- Step 2: Select channels using the procedure [Select channels:, page 8](#).
- Step 3: Set levels for those channels using the procedure [Set Channel Levels, page 8](#).
- Step 4: Press **[Record] [Focus Point] [#] [Enter]**.



Americas ■ 3030 Laura Lane, P.O. Box 620979, Middleton, Wisconsin 53562-0979 USA ■ Tel: +608 831 4116 ■ +800 688 4116 ■ Fax: +608 836 1736 ■ +800 555 8912
Europe ■ Unit 4, Victoria Industrial Estate, Victoria Road, London W3 6UU, UK ■ Tel: +44 (0)20 8896 1000 ■ Fax: +44 (0)20 8896 2000
Asia ■ Room 605-606, Tower III Enterprise Square, 9 Sheung Yuet Road, Kowloon Bay, Kowloon, Hong Kong ■ Tel: +852 2799 1220 ■ Fax: +852 2799 9325
Web: www.etconnect.com ■ **Email:** (US) mail@etconnect.com ■ (UK) mail@etceurope.com ■ (Asia) mail@etcasia.com
Service: service@etconnect.com ■ Toll free: 800 775 4382 ■ Comments about this document: techcomm@etconnect.com
Copyright © 2002 Electronic Theatre Controls, Inc. All Rights Reserved. Product information and specifications subject to change.
® 4110M1300-3.1 ■ Rev A ■ Released 11/02